



泓成包装 轻轻松松

Hongcheng Machinery Makes Your Job Easier and Save Cost

中山泓成智能化设备有限公司

Zhongshan Hongcheng Intelligent Equipment Co., Ltd.

<http://www.hongchengmachine.com>

Email: 1055959048@qq.com

madeinchinahc@163.com

Tel: 86-13528154100

ADD: No. 3, Wentian New Street, Xiaolan Town,
Zhongshan, Guangdong, China

广东省中山市小榄镇文田新街3号

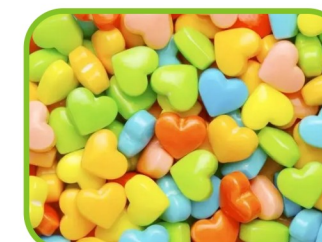

Zhongshan **Hongcheng**

Intelligent Equipment Co., Ltd.

中山泓成智能化设备有限公司

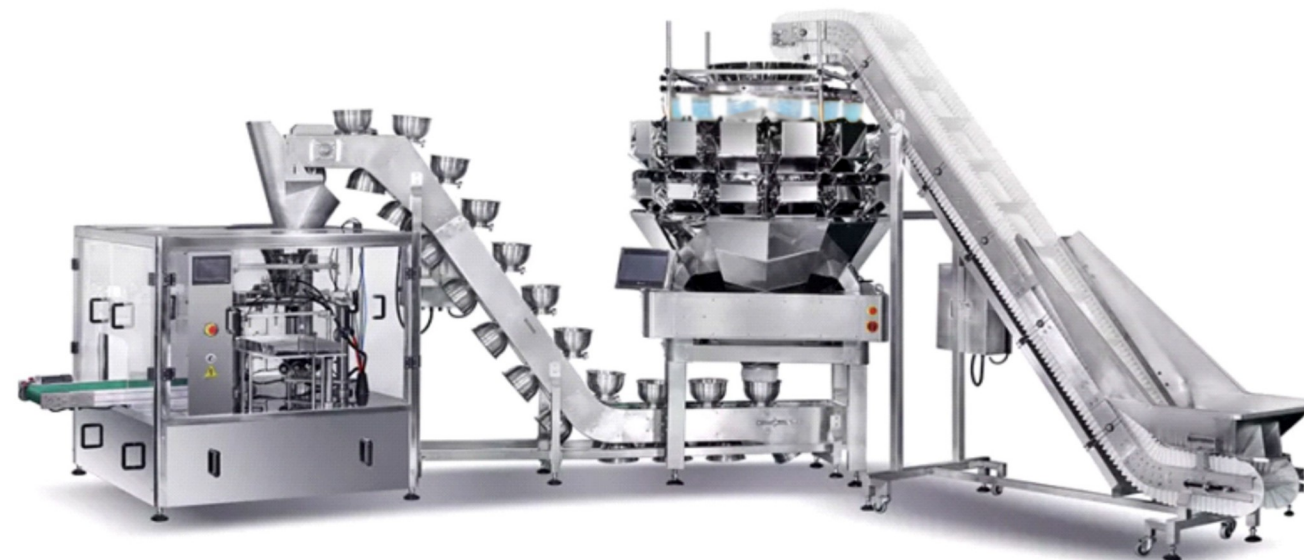

公司简介 Company Profile



中山泓成智能化设备有限公司是一家集开发、研发、生产制造、营销与服务为一体的加工生产制造企业，并拥有专业的研发团队。主要生产Z型提升输送机、大倾角提升输送机、碗式提升机、平台及成品输送机、五金配件及非标定制一体化提升输送机及配套定量包装系统，解决在提升机上输送多种物料及实现自动定量包装的问题，大大节省客户各方面的成本。该系列包装产品广泛应用于食品、化工、制药、饮料、农产品、玩具、工业等行业的物料的传送运输和包装。客户需求的目的是基于产品的演示和实用经验分析，泓成智能公司不断推出新产品以满足市场的需求发展。

泓成智能公司一直坚持“诚信”、优质、创新”的经营理念，以客户需求为导向。客户的满意，是泓成智能人的追求。泓成智能公司以高质量的产品，良好的售后服务，公平合理的价格竭诚为广大客户服务，与新老、中内外客户共同发展，互惠互利，共同创造美好的明天。

质量方针：质量保证，持续创新，尽最大努力赢得客户百分百满意。

Zhongshan Hongcheng Intelligent Equipment Co., Ltd. is one of the leading packing system solution manufactures in China. We focusing on researching, developing, designing, manufacturing, sales marketing and service of multi-function packing system and Elevator Conveyors Machinery Equipments, and has a very professional R & D team. We dedicated in producing Z-type lifting conveyor, large inclined angle elevate conveyor, bowl conveyor, working platform and finished product conveyor machinery, hardware accessories products, non-standard customized integrated lifting conveyor and supporting quantitative packaging system which solves the problem of conveying a variety of materials on the elevate conveyor and realizing automatic quantitative packaging. This is greatly save the cost of all aspects of customers. This series of packaging machinery are widely used in the packaging and transportation of food, chemical, pharmaceutical, beverage industry, agricultural products, toys industry and other industries. The purpose of customers' demand is based on products' demonstration and practical experience analysis, Hongcheng intelligent Equipment Company constantly introduces new products to meet the development of the market.

Hongcheng Intelligent Equipment Company has always adhered to the business philosophy of "integrity, quality and innovation", be customer-oriented. Customer satisfaction is the pursuit of Hongcheng intelligent Equipment Company people. With high-quality products, good after-sales service and fair reasonable prices, Hongcheng intelligent Equipment Company will wholeheartedly serve our customers, develop together with new and old customers, Chinese and foreign customers to create a better tomorrow for mutual benefit.

Quality policy: quality assurance, continuous innovation, do our best to win the customers' 100% satisfaction.

全自动包装系统，输送线设备
Automatic Packaging System, Conveyor Equipment

» 目录

- 01 Z型物料提升机&全自动称重包装系统
Z Type Material Elevator & Automatic Weighing Packing System
- 02 碗式提升输送机&全自动称量包装系统
Bowl Conveyor & Automatic Weighing Packing System
- 03 螺旋杆提升机
Screw Conveyor
- 04 大倾角提升输送机&全自动包装系统
Large Angle Inclined Conveyor & Automatic Weighing Packing System
- 05 单斗提升机
Single Bucket Elevator
- 06 成品输送机
Finished Product Conveyor
- 07 工作平台
Working Platform
- 08 滚筒输送机
Roller Conveyor
- 09 大倾角提升输送机
Large Angle Inclined Elevate Conveyor
- 10 304不锈钢塑料/塑料链板输送机
SUS304/Plastic Chain Plate Conveyor
- 11 多规格料斗提升机&全自动重量包装系统
Multi-Specification Bucket Elevator & Automatic Weighing Packing System
- 12 网面输送机
Mesh Wire Belt Conveyor
- 13 分拣机
Sorting Machinery
- 14 振动给料机
Vibrating Feeder Machine
- 15 配套辅件
Accessories
- 16 热销产品 / 全自动称重包装系统
Hot Selling Products / Full Automatic Weighing and Packaging system

Z型物料提升机&全自动称重包装系统
Z Type Material Elevator & Automatic Weighing Packing System

▶▶ 适用范围 Applications

用于包装膨化食品、零食等颗粒、薯条、花生，糖果、糖、盐、味精、葵花籽、坚果、玉米粉、茶叶、巧克力、香草或五金制造品等，适用于各种易碎和不易碎物料提升。

This machine for packing granules like puffed food,snacks,chips,peanut,candy,sugar,salt,MSG,sunflower seeds,nuts,cornmeal,tea leaves,chocolate,herbs or hardware etc.Suitbale for the lifting of frangible and nonfrangible material.

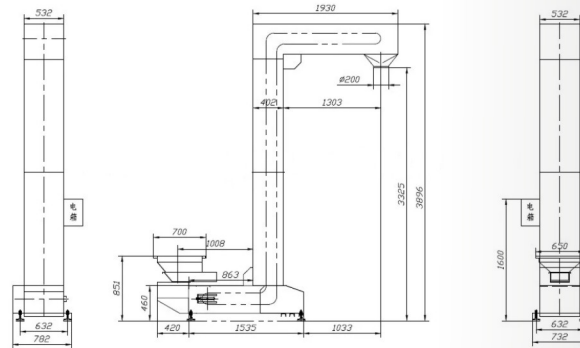

▶▶ 主要结构和性能特点 Features

- 该提升机与电子计量称配套使用，并用控制电路以料位控制，实现自动供料和停止的自动化功能。
- 有不锈钢和碳钢两种材料制造，可供客户选择。
- The elevator and electronic metering scale shall be used together,control circuit is used to control the position of the material,realizing automatic feeding and stopping function.
- The elevator can be made of stainless steel and carbon steel according to the customer's choice.

▶▶ 主要技术参数 Main Technical Parameter

产品型号 Art.NO.	HC 0203001
主要材质 Material	SUS304
斗料容量 Hopper Volume	1.0L/1.8L/3.6L
料仓容量 Storage Volume	70L/100L/150L/200L
电压 Voltage	220V/380V 50Hz/60Hz
功率 Power	0.75KW-2.2KW
输送量 Conveying Capacity	2.5m ³ /h、4m ³ /h、8m ³ /h
外形尺寸 Product Dimension	W2988mm x H3896mm/Customized

▶▶ 适用范围 Applications

我们的设备广泛应用块状和颗粒状物料给还有不粘的物料，如流动性好的粉末，豆粉，面粉，胡椒粉，饲料粉，奶粉，咖啡粉等粉状类物料的包装或用于化工、医药、农产品、工业品等领域；

自动提升输送部分重量固体，颗粒状，小型产品，更多的是由于现场空间的二次提升解决方案。

Our equipment is widely used in the field of packing for block and granule material,non-sticky and with flow property powdery-goods,such as soybean flour,chili powder ,feedstuff powder,milk powder,coffee powder. etc.or suitable for chemicals,medicines,farm products and industrial products.

Auto lift-conveying of portion weight solid, granular, small-sized products, and more often for secondary lifting solution due to field space limitation.



▶▶ 主要结构和性能特点 Features

- 非常容易学习和操作。
- 包装任何东西，从液体，宠物食品，粉末，五金配件等产品。
- 易于集成秤，进料和出料输送设备，以及更多。
- 快速密封，坚固耐用的不锈钢结构。
- Incredibly easy to learn and operate.
- Package anything from liquids, to pet foods, to powders, to legal cannabis products.
- Easy integration with scales, infeed and outfeed conveying equipment, and more.
- Rapid sealing,durable stainless construction.

▶▶ 主要技术参数 Main Technical Parameter

产品型号 Art.NO.	HC 0203019
主要材质 Material	SUS304
斗料容量 Hopper Volume	0.8L / 1.4L / 3L
运行速度 Speed	10-40 buckets/minute
电压 Voltage	single/3 phase 220V/380V 50HZ/60HZ
功率 Power	0.75KW-1.5KW
输送量 Conveying Capacity	1-6 cubic meters/H
外形尺寸 Product Dimension	H2213mm/Customized

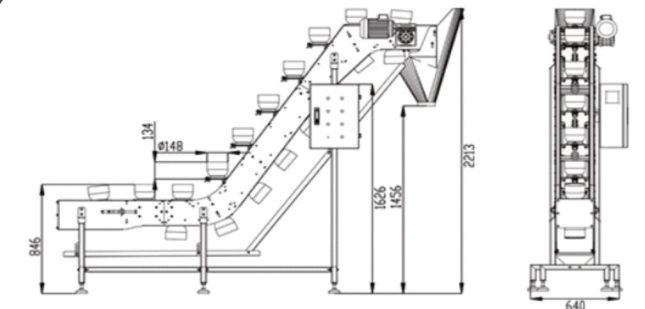
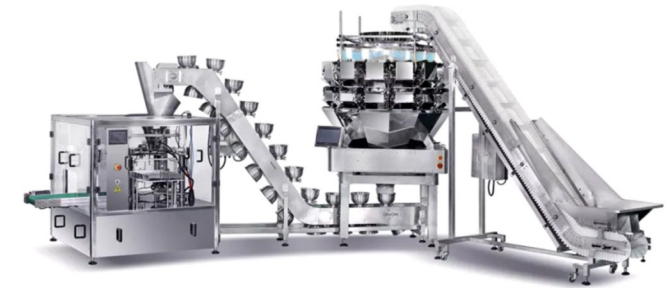

螺旋杆提升机
Screw Conveyor

▶▶ 适用范围 Applications

我们的设备广泛应用不粘，如流动性好的粉末，豆粉，面粉，胡椒粉，饲料粉，奶粉，咖啡粉小麦、玉米、大豆等粉状类物料的包装，以及水泥、塑料、沙子、木屑、干粉等建筑，化工，医疗等领域。

Our equipment is widely used in the field of packing for non-sticky and with flow property powdery-goods, such as soybean flour, chili powder, feedstuff powder, milk powder, coffee powder, wheat, corn, soybeans, etc., as well as cement, plastic, sand, wood chips and dry powder, etc. or suitable for construction, chemical, medical and other fields.

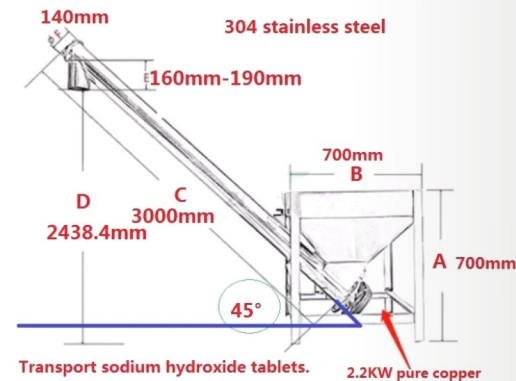

▶▶ 主要结构和性能特点 Features

- 产品漏斗可与管分离，便于组装。
- 特殊防尘设计，保护轴承防尘。
- 为了方便机器清洗，增加了以下功能：螺旋钻可反转排空管，产品卸料门安装在漏斗底部，螺旋钻可拆卸清洗。
- Product funnel can separate from the tube for easy assembly.
- Special anti-dust design to protect bearing from dust.
- In order to convenience machine cleaning, following functions are added in: auger can reverse for emptying the tube, product discharge gate is mounted in the bottom of the funnel, auger can be disassemble for washing.

▶▶ 主要技术参数 Main Technical Parameter

产品型号 Art.NO.	HC 0203034
主要材质 Material	SUS304
料仓容量 Storage Volume	100L/200L
电压 Voltage	220V/380V 50Hz/60Hz
功率 Power	0.75KW-4KW
输送量 Conveying Capacity	2m ³ /h、3m ³ /h、5m ³ /h、8m ³ /h
输送角度 Angle of conveyor	60 / 45 / 30
管直径 Tube Diameter	110, 140, 160, 168, 219mm
外形尺寸 Product Dimension	1500*500*500mm/Customized



大倾角提升传送机&全自动包装系统
Large Angle Inclined Conveyor & Automatic Weighing Packing System

▶▶ 适用范围 Applications

适用于食品，如零食，冷冻食品，蔬菜，水果，糖果等，还用于农业，制药业，化工等行业。将物料从地面提升的设定的顶部。

It is widely used in food industry, such as snacks, snacks, frozen food, vegetables, fruits, candy, etc. also used in agriculture, pharmaceutical, chemical and other industries. This packing machine is for lifting material from the ground to the setting top.



▶▶ 主要结构和性能特点 Features

- 输送带采用食品级PP材质，模具法制作，外观粘接，不易变形，耐高低温，易与各类喂料设备接口，可直接对输送带进行清洗；振动给料器可根据信号要求将物料有序给到输送带上；安装拆卸方便，清洗方便。
- Conveyor belt is made of food grade PP material, made by mould method, sticky appearance, not easy to deform, high and low temperature resistance, easy to interface with various types of feed equipment. Vibrator feeder will feed materials to carry belt orderly according to signal easy. Easy to install and disassemble, and easy to clean.

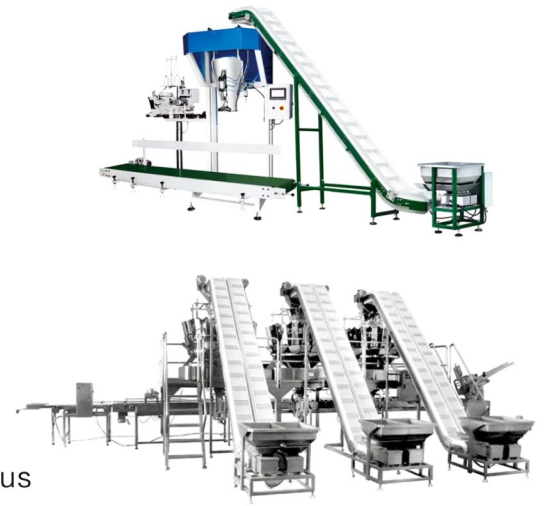

▶▶ 主要技术参数 Main Technical Parameter

产品型号 Art.NO.	HC 0203010
主要材质 Material	SUS304
传送高度 Convey Height	1800-4500 mm
输送量 Conveying Capacity	4-6m ³ /h
振动料斗尺寸 Vibrator Hopper Size	650L*650W/Customized
电压 Voltage	220V/380V 50Hz/60Hz
功率 Power	0.75KW-1.5KW
外形尺寸 Product Dimension	6000L*900W*1000H mm / Customized
宽度或直径 Width or Diameter	100/200/300/400/500/600mm

单斗提升机
Single Bucket Elevator

▶▶ 适用范围 Applications

斗式提升机广泛应用于食品、农业、化工行业的一系列自由流动产品。
Single Bucket elevator is very well suited for a board range of free flow products in the food, agriculture, chemicals industry.



▶▶ 主要结构和性能特点 Features

- 采用304不锈钢卫生建筑及食品级塑料。
- 省力输送机, 允许大量物料移动。运行可靠, 能耗低。耐腐蚀、耐磨。
- 运行噪音低, 操作简单。需要维修费用低。容易清洁。
- 可根据客户需要定制。
- Adopt SUS304 sanitary building and food grade plastic.
- Labor saving conveyor, allowing a large amount of material movement. Reliable operation and low energy consumption. Corrosion resistance and wear resistance.
- Low running noise and simple operation. Requires low maintenance. Easy to clean.
- Can be customized according to customer needs.

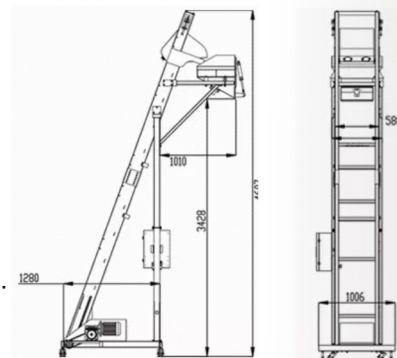

▶▶ 主要技术参数 Main Technical Parameter

产品型号 Art.NO.	HC 0203064
主要材质 Material	SUS304
筒仓容量 Bucket Volume	30L/50L/60L/80L/100L/120L
电压 Voltage	Three phase AC380V /220V 50HZ
功率 Power	0.55KW-1.55KW
输送速度 Conveying Speed	0~10m/min
输送量 Conveying Capacity	2-6m ³ /h
重量 Weight	100kg
外形尺寸 Product Dimension	H3250mm /Customized



成品传送机
Finished Product Conveyor

▶▶ 适用范围 Applications

用于将成品袋输送到检测台用于包装。
带式 and 链式均可定制。
Used to transport finished product to test bench for packaging.
Belt type and chain type can be customized.

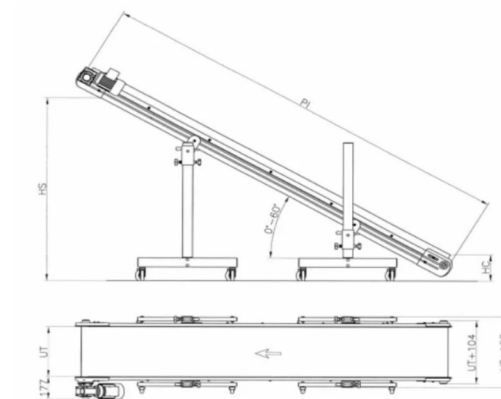

▶▶ 主要结构和性能特点 Features

- 本产品采用微型电动机传动, 低噪音, 寿命长, 可将成品输送到平台, 在包装过程中减少废品, 令包装机工作顺畅, 提高工作效率。
- Adopts micro motor conveying, low noise, long life, it can transport the finished product to the platform, reduce waste during the packaging process and take the finished products away in time to make the packaging machine work smoothly, improve work efficiency.



▶▶ 主要技术参数 Main Technical Parameter

产品型号 Art.NO.	HC 0203064
主要材质 Material	SUS304
传送速度 Speed	10-40m /min
电压 Voltage	220V/380V 50Hz/60Hz
功率 Power	0-80W
外形尺寸 Product Dimension	L1400*W500*H1400mm/Customized
宽度或直径 Width or Diameter	300/450/600mm

工作平台
Working Platform

▶▶ 适用范围 Applications

适用于小型及其它大型机械的配套。
主要用于将物料输送到多头智能组合秤、配套包装机及相关设备。
It is suitable for supporting the small and other big machines.
It mainly used to carry materials to multi-head intelligent combination weigher, supporting packaging machine and related equipment.

▶▶ 主要结构和性能特点 Features

- 材料为全不锈钢，紧凑的刚性设计和建造；
- 按客户要求订制；
- 安全保护。梯子、平台和扶手；
- 适用于多头或线性。容易简单的维护。
- Made of stainless steel, Compact rigid design and build;
- Customized to order;
- Safety protection. Ladder and Platform with handrail;
- Suitable for multihead or linear. Easy and simple maintenance.



▶▶ 主要技术参数 Main Technical Parameter

产品型号 Art.NO.	HC 0203060
主要材质 Material	SUS304
平台高度 Platform height	Fixed
承重范围 Support weight range	200kg-1000kg
外形尺寸 Product Dimension	1900*1900*1900 / Customized

滚筒输送机
Roller Conveyor

▶▶ 适用范围 Applications

适用于建材车间，机械修理厂，制造工厂，食品饮料厂，农场，建筑工程，能源和采矿等行业。
Suitable for building material shops, machinery repair shops, manufacturing plant, food & beverage factory, farms, construction works, energy & mining etc.



▶▶ 主要结构和性能特点 Features

- 该滚筒输送机结构简单，可靠性高，使用维护方便。
- 输送机结构简单，可靠性高，使用维护方便。滚筒输送机适用于平底物品的输送，主要由传动滚筒、机架、托架、传动部分等组成。它具有运量大、速度快、运行轻便、能实现多条线路同时传输的特点。
- The roller conveyor has a simple structure, high reliability, and convenient use and maintenance.
- The roller conveyor is suitable for the conveyance of articles with a flat bottom, which is mainly composed of a driving drum, a frame, a bracket, a driving part and the like. It has the characteristics of large transport volume, high speed, light operation, and the ability to realize the transmission of multiple lines at the same time.

▶▶ 主要技术参数 Main Technical Parameter

产品型号 Art.NO.	HC 0203012
主要材质 Material	SUS304
承重 Load-bearing	0~30meter/min, Customized
输送量 Conveying Speed	10-50M/M or as your required
传送高度 Convey Height	450-1600mm
最大承重 Max load capacity	60kg/meter
电压 Voltage	220V/380V 50Hz/60Hz
功率 Power	0KW-5KW
外形尺寸 Product Dimension	6000mm L*600mmW*500-1200mmH / Customized
钢管直径 Roller Diameter	∅50mm O-belt steel roller with precision bearing

大倾角提升输送机
Large Angle Inclined Elevate Conveyor



▶ **适用范围 Applications**

边墙胶带输送机广泛应用于煤炭、粮食、建材、化工、水电、冶金等行业。适用于温度-19℃~ +40℃范围内，输送密度在0.5-2.5 t/m³的各种物料。
Sidewall rubber belt conveyor is widely used in coal, grain, building materials, chemical industry, water and electricity, metallurgy and other industry. It convey all kinds of material whose density is 0.5-2.5 t/m³ in the temperature-19° C~+40° C.

▶ **主要结构和性能特点 Features**

- 经济实用，性价比高；模块化组合，便于运输和维护；
- 运行可靠、噪音低、安全；可调腿，适用范围广；
- 表面静电喷涂或其他表面颜色处理，外形美观；
- 可调传达速度；超大的负载能力；轻量化设计，安装速度快。
- Economic and practical, cost-effective ; Modular combination, easy to transport and maintain;
- Reliable operation, low noise and safety ; Adjustable legs, wide application scope;
- Surface electrostatic spraying or other surface color treatment, beautiful appearance;
- Adjustable convey speed; Large load capacity; Lightweight design, fast installation;



▶ **主要技术参数 Main Technical Parameter**

产品型号 Art.NO.	HC 0203002
主要材质 Material	SUS30+PU/PVC Belt
可变速率 Variable Speed	0~30meter/min,Customized
输送量 Conveying Capacity	2.5m ³ /h、4-6m ³ /h、8-12m ³ /h
传送高度 Convey Height	200-3000 mm
电压 Voltage	220V/380V 50Hz/60Hz
功率 Power	0.75KW-2.2KW
外形尺寸 Product Dimension	2050*1350*980mm / Customized
宽度或直径 Width or Diameter	300/400/500/650/800mm

304不锈钢/塑料链板输送机
SUS304/Plastic Chain Plate Conveyor

▶ **适用范围 Applications**

广泛应用于食品、饮料厂、灌装、制药、化妆品、洗涤剂、纸制品、调味品、乳制品、烟草、化工、医疗等行业。
Suitable for food, beverage factory, filling, pharmaceuticals, cosmetics, detergents, paper products, condiments, dairy products and tobacco chemical, medical industries.
Garment Shops, Building Material Shops, Machinery Repair Shops.



▶ **主要结构和性能特点 Features**

- 该皮带/链板输送机结构简单，可靠性高，使用维护方便。是各种饮料生产线的必备设备。
- 用于饮料生产线上，将各独立的机器连接成一条完整的自动线。输送带的长度、宽度、材质可根据客户要求定制。
- 具有破瓶率低，速度可调，高度可调，与机器配套，操作方便，寿命长等特点。
- The belt/chain plate conveyor has the advantages of simple structure, high reliability and easy maintenance. It is a necessary equipment for various beverage production lines.
- Used in beverage production line, connect each independent machine into a complete automatic line. Conveyor belt length, width, material can be customized according to customer requirements.
- It has the characteristics of low breaking rate, adjustable speed, adjustable height, matching with the machine, easy operation, long life etc.

▶ **主要技术参数 Main Technical Parameter**

产品型号 Art.NO.	HC 0203056
主要材质 Material	SUS304 + Plastic Chain Plate Belt
可变速率 Variable Speed	0~30meter/min,Customized
输送量 Conveying Capacity	6000-8000bottles/h
可移动瓶身宽度 Width Of The Movable Bottles	0-100mm
可调节高度 Height Adjustment	860-1010mm
电压 Voltage	220V/380V 50Hz/60Hz
功率 Power	0.37KW for 2-4m 0.55 for 6m/Customized
外形尺寸 Product Dimension	2, 4, 6, 8, 10m/Customized
宽度或直径 Width or Diameter	Width: 63.5mm-304.8mm

多规格料斗提升机&全自动重量包装系统
Multi-Specification Bucket Elevator & Automatic Weighing Packing System

▶▶ 适用范围 Applications

Z型斗式提升机适用于各种类型的物料包装，从食品，建筑，化学，医疗等行业，Z型斗式提升机都是经过精心设计，经久耐用。

Z Type Bucket Elevator is suitable for all types of material packaging from food, construction, chemistry, medical and other industries, Z type bucket elevator is carefully designed and durable.

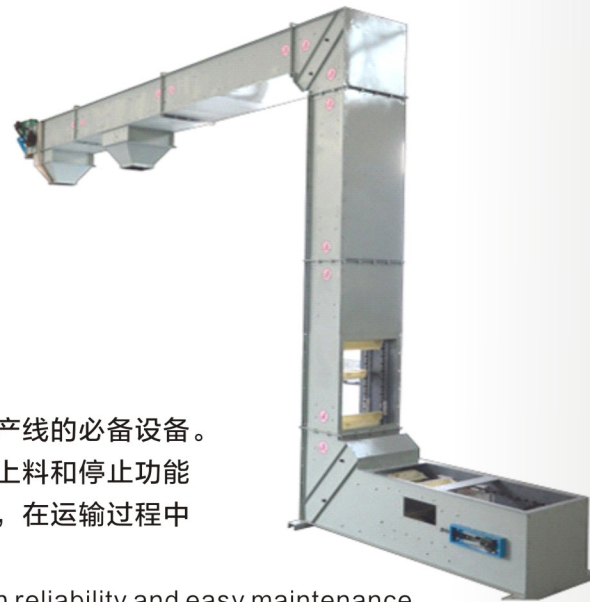

▶▶ 主要结构和性能特点 Features

- 该链条输送机结构简单，可靠性高，使用维护方便。是各种物料生产线的必备设备。
- 电梯与电子计量秤配合使用，控制电路控制物料的位置，实现自动上料和停止功能
- 垂直提升可节省占地空间，动力损失小，因为物料在铲斗中的堆积，在运输过程中一直处于相对静态，不会因运输损坏而造成。
- The chain lift conveyor has the advantages of simple structure, high reliability and easy maintenance.
- It is a necessary equipment for various material production lines.
- The elevate conveyor machinery should be used with electronic metering scale, control circuit controls the position of the materials that realizing automatic feeding and stopping function.
- Vertical lifting save floor space, small power loss as the accumulation of material in the bucket, has been in a relatively static state during transportation, not caused any damage by transportation.



▶▶ 主要技术参数 Main Technical Parameter

产品型号 Art.NO.	HC 0203066
主要材质 Material	SUS304+Pastic Bucket
可变速率 Variable Speed	0~30m/min, Customized
传送距离 Conveying Distance	2~25m
传送高度 Lifting Height	0~50m
输送量 Delivery volume	0~12m ³ /h
单个料斗容量 Single bucket capacity	5L/6L/8L/12L
宽度或直径 Width or Diameter	300/400/500/650/800mm
电压 Voltage	220V/380V 50Hz/60Hz
功率 Power	0.37KW~3.5KW
外形尺寸 Product Dimension	Customized

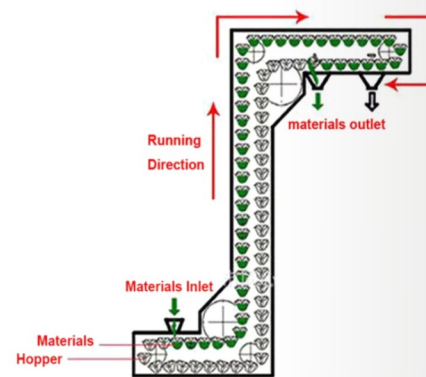

▶▶ 适用范围 Applications

网面输送机广泛应用于食品、瓶装饮料、灌装、制药、化妆品、洗涤剂、纸制品、调味品、乳制品、烟草，化工，医疗等行业。精心设计，经久耐用。

Mesh Wire is widely used in food, bottle beverage, filling ling, pharmaceuticals, cosmetics, detergents, paper products, condiments, dairy products, tobacco, chemical, medical industries etc.

▶▶ 主要结构和性能特点 Features

- 该网面输送机结构简单，可靠性高，使用维护方便。是各种物料生产线的必备设备。
- The mesh wire conveyor has the advantages of simple structure, high reliability and easy maintenance. It is a necessary equipment for various material production lines.

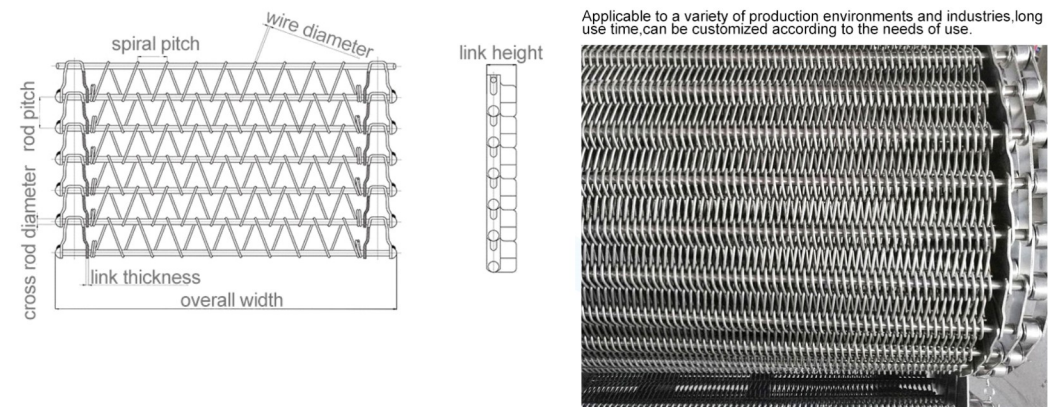

▶▶ 主要技术参数 Main Technical Parameter

产品型号 Art.NO.	HC 0203009
主要材质 Material	SUS304
可变速率 Variable Speed	0~30m/min, Customized
传送距离 Conveying Distance	2~25m
输送量 Delivery Volume	1~500kg/h or Customized
电压 Voltage	220V/380V 50Hz/60Hz
功率 Power	0.37KW~3.5KW
外形尺寸 Product Dimension	Customized

网面输送机
Mesh Wire Belt Conveyor

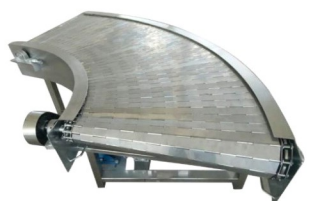
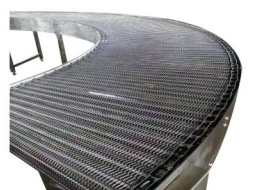
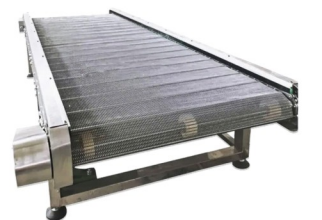

分拣机
Sorting Machinery

▶▶ 适用范围 Applications

分拣机广泛应用于食品、海产品如海参、鲍鱼、墨鱼干以及应用于制药、化妆品、洗涤剂、烟草，化工，医疗等行业。适合检查各种产品的重量，重量过多或过少都会被挑出，合格的包装产品会被直接流到下一设备。

The sorting machinery is widely used in food and seafood, such as sea cucumber, abalone, dried cuttlefish and widely used in pharmaceutical, cosmetic, detergent, tobacco, chemical, medical industries and other industries. It is suitable for checking the weight of various products. Too much or too little weight will be picked out, and qualified pack will be directly sent to the next equipment.

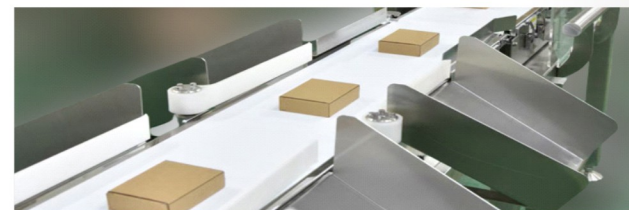

▶▶ 主要结构和性能特点 Features

- SUS304材质,耐用,美观,可靠性高,使用维护方便;
- 检查精度可达0.1g;
- 采用先进的数字信号处理,实现高速稳定称重与精准分拣;
- 抗振动和干扰设计强。
- Made of 304 stainless steel, durable and nice appearance, high reliability, easy to use and maintenance.
- Check accuracy is upto 0.1-0.5g.
- Apply advanced digital signal processing and realize high speed and stable weighing and precision sorting.
- Strong anti-vibration and strong anti-interference design

▶▶ 主要技术参数 Main Technical Parameter

产品型号 Art.NO.	HC 0203068
主要材质 Material	SUS304
最大速度 Max.Speed	120piece/min, Customized
传送距离 Conveying Distance	2-25m
称重范围 Weighing range	5-1200g
最小精度 Min.accuracy	± 0.5g
电压 Voltage	220V/380V 50Hz/60Hz
功率 Power	0.37KW-3.5KW
外形尺寸 Product Dimension	3.245m*1.056*1.355/Customized 2-25m

振动给料机
Vibrating Feeder Machine

▶▶ 适用范围 Applications

广泛应用于食品、灌装、制药、化妆品、洗衣粉、纸制品、化工、医疗、烟草等行业。

Vibrating Feeder Machine is widely used in food, filling, pharmaceutical, cosmetics, Washing powder, paper products, chemical, medical, tobacco and other industries.

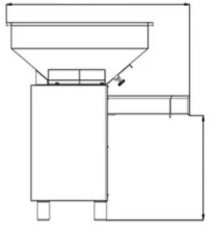
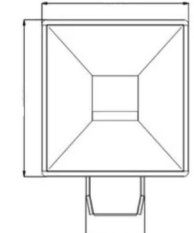
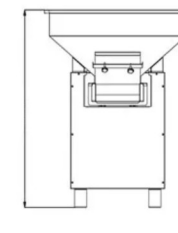

▶▶ 主要结构和性能特点 Features

- SUS304材质,耐用,美观,可靠性高,使用维护方便。
- 振动给料机表面有光滑和波文两种。
- 振动给料机是一种利用振动来“给”物料到一个过程或机器的仪器。
- 振动给料机利用振动移动物料。
- 广泛用于自动给料从小到大的和形状各异的食物。
- SUS304 material, durable, beautiful, high reliability, easy to use and maintenance.
- Hopper surface: Smooth or dimpled.
- A vibratory feeder is an equipment that uses vibration to "feed" material to a process or to a machine.
- Vibratory feeders use vibration move material.
- It is widely used to automatically feed food from small to large and of various shapes material.

▶▶ 主要技术参数 Main Technical Parameter

产品型号 Art.NO.	HC 0203070
主要材质 Material	SUS304
振盘长度 Vibration plate length	0.8m-2m/Customized
料斗尺寸 Hopper size	880(L)*880(W)mm/Customized
料斗容量 Hopper volume	100L/200L/Customized
机械高度 Machine height	1200mm/Customized
输送量 Conveying Capacity	2m ³ /h - 8m ³ /h
电压 Voltage	Single phase 220V 50Hz/60Hz(单相)
功率 Power	0.3KW-1.5KW
外形尺寸 Product Dimension	1200mm*880mm*880mm/Customized



配套辅件
Accessories

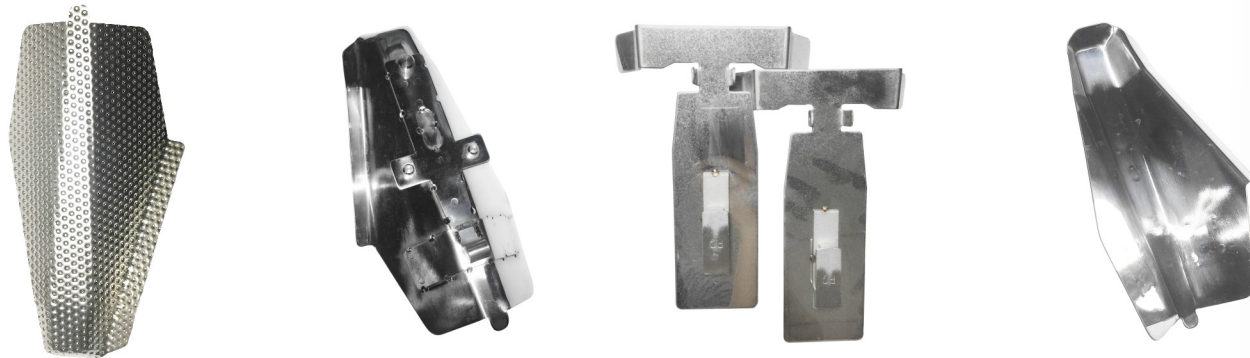

SUS304/316线振卷加料给料配件
SUS304/316 Feeding Bucket

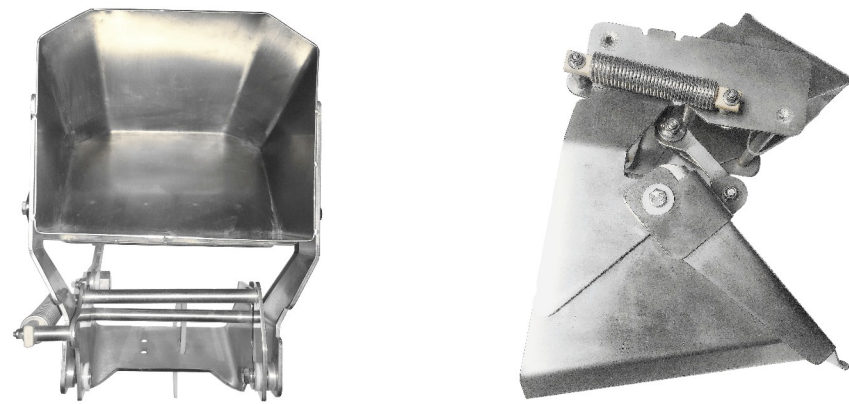

SUS304/316料斗
SUS304/316 Hooper



SUS304/316 设备拉手
SUS304/316 Handrail



SUS304/316 防水盖
SUS304/316 Waterproof Cover



SUS304/316 多头料斗
SUS304/316 Multiheads Hooper

热销产品
Hot Selling Products



塑料链板传送线
Plastic Chain Conveyor



新型立式包装机
New Type Vertical Form Filling Machinery



大倾角提升机
Inclined Conveyor



碗式提升机
Bowl Conveyor



量杯机
Volume Cup Doser



工作平台
Working Platform



大倾角提升机
Inclined Conveyor



螺杆上料机
Auger Conveyor

全自动称重包装系统
Full Automatic Weighing and Packaging system



碗式提升机包装系统
Bowl Conveyor Packing System



给袋式称重包装系统
Weighing&Packing System



全自动包装系统
Full Automatic Packing System



螺杆提升机直立式包装系统
Screw Conveyor Vertical Packing System



单斗提升机
Single Elevator



小型号提升机包装系统
Small Conveyor Packing System



全自动系统配大倾角提升机
packaging system with Inclined conveyor



Z型提升机包装系统
Z Type Elevate Conveyor Packing System